

Users Manual

f a f N e R



Contents:	Page:	Page:
Introduction	2	Rear Panel Connections 10
Getting Started	3	Channel Reference 12
Front Panel Controls	4	Specifications 14
Block Diagram	8	

EBS FAFNER II - XD EXTREME EDITION

MADE IN SWEDEN BY EBS SWEDEN AB

✉ GRINDSTUVÄGEN 44-46, SE-16733 BROMMA, SWEDEN

☎ +46 8 735 00 10, FAX : +46 8 735 00 05

E-MAIL: ebs.info@bass.se

WEB: www.ebssweden.com



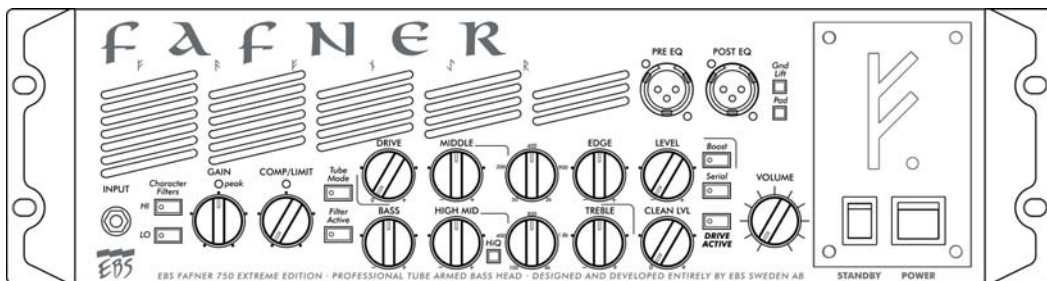

For more than a millennia ago, there was in the Nordic countries a legend about a family consisting of a man named **Reidmar** and his three sons, **Utter**, **Regin** and **Fafner**.

One day when Utter was at the river taking a bath in his animal form of an otter, he was by mistake killed and devoured by the evil god Loki. At this, Reidmar was of course outraged and demanded a ransom from the Father of all Gods, Odin. The ransom demanded was Utter's otterskin covered by gold to the last whisker. The gods saw no other solution than to comply with this and gave Reidmar what he asked for.

Fafner and Regin became very angry with their father who didn't want to share his treasure. Finally they decided to kill their father to get the treasure, and so did.

Not long after the two brothers had killed their father, Fafner became so greedy that he determined to kill his brother Regin to get the treasure for himself.

Knowing that his treasure would not be safe in the family's house, he dragged it to a cave far from the house. After he had assured himself that all the traces were gone he transformed himself into a gigantic snakelike dragon and settled down to guard his treasure.

The raw power and cruelty of Fafner the Dragon, is what EBS Sweden has incorporated in our new Basshead.

The tube armed Fafner Basshead is targeting the sound-conscious Bassplayers who know what they want; the best possible sound.

EFFECTS LOOPS:	Loop Signal Level	nominal	-10 dBv
	Gain		Unity (1:1)
	Output Impedance (Sends)		<100 ohms
	Input Impedance (Returns)		47 kohms // 100 pF
REMOTES:	Connection:	REMOTE JACK:	RING = Mute TIP = Drive
	Function:	FILTER JACK:	RING = Filter Section TIP = Character Connect to GND for bypass.
	Threshold		0.7 V
	Current		5 mA suitable for LED
TUNER OUT:	Output Impedance:		< 25 kohms
	Signal Level		As Instrument
LINE OUT:	Output Impedance		<100 ohms
	Nominal Signal Level		0 dBv
AMP INPUT:	Input Impedance		10 kohms
	Sensitivity		32 dB (40x)
POWER AMP:	Continuous Output Power		>600 W RMS @ 4 ohms Impedance 750 W RMS @ 2 ohms Impedance
AUXILIARY INFO:	Power Requirements	max	900 W
	Mains Protection:		T6.3A Fuse (230V) T10A Fuse (100/120V)
	Dimensions (WxDxH):		48 cm x 36 cm x 13 cm 19" x 14" x 5.2"(3U)
	Weight:		16 kg (36 lbs.)

Specifications are subject to change without notice!

INPUT:	Input Impedance		2 Mohms // 100 pF	
GAIN:	Gain Range	min/max	-∞/ +30 dB	
	Gain Peak LED		+10 dBv	
	Frequency Response	+0 / -3 dB	20 - 20.000 Hz	
CHARACTER:	Filter:	Type	Shelving High/Low Pass	
	Gain:	Lo	+9 dB @ 40 Hz	
		Hi	+6 dB @ 8 kHz	
COMP/LIMIT:	Compressor Gain		0 dB	
	Attenuation	max	24 dB	
	Compression Ratio	max	3:1	
	Attack (80%)	typ	<10 ms	
	Release (80%)	typ	100 ms	
FILTER SECTION:	Bass Filter:	Type	12 dB/oct. Shelving	
		Gain Range	+/- 18 dB @ 80 Hz	
	Hi Middle Filter:	Type	Bandpass Filter	
		Frequency Range	100 - 4.500 Hz	
		Q - Normal	0.7	
		Q - Hi-Q mode	1.8	
	Gain Range		+/- 15 dB	
	Treble Filter:	Type	Shelving	
		Gain Range	+/- 15 dB @ 10 kHz	
	DRIVE SECTION:	Gain Range	min/max	0 / 34 dB
			Low End Compensation	(Boost off)
Modes			Solid State / Tube	
Tube Type			ECC83 (European type)	
Tube Heating			DC	
Middle Filter:		Type	Bandpass Filter	
		Frequency Range	50 - 2.000 Hz	
		Q	1.0	
Gain Range			+/- 15 dB	
Edge Filter:		Type	Bell Filter	
		Gain Range	+/- 12 dB @ 6 kHz	
BALANCED OUTPUT:	Output Level	Nominal/Padded	+4 dBm / -30dBm	
	Output Impedance		< 10 ohms current lim.	
	Frequency Response	+0/-3 dB	10 - 20k Hz	
	Dynamic Range:	linear/A-w.	102/105 dB typ.	
	XLR Connections		1-GND, 2-Hot, 3-Cold	
	Options		GND Lift, Pad	

Congratulations on your choice of the EBS Fafner bass head !

The **EBS Fafner II XD** is the most powerful, versatile and complete bass head ever built. With two separate channels, extensive routing possibilities, built in compressor, tube section, dual balanced outputs and super powerful EQ sections, the amp offers an extremely wide range of sound possibilities.

GETTING STARTED...

- Carefully unpack the bass head.
- Check that all knobs are set fully counter clockwise besides the EQ controls marked BASS, HI MID, TREBLE, MIDDLE and EDGE which should be set to mid position. Make also sure all push switches are set to their outer positions. Now the EBS Fafners settings are "zeroed" and ready to be personalized.
- Turn on the POWER switch. Wait for approx. 15 seconds before switching on the STANDBY switch to allow the tube to warm up.
- Plug in your bass. While plucking the strings as hard as you would during your hardest playing, gradually increase the GAIN knob until the peak LED starts to flash at peaks.
- Move over to the VOLUME knob and adjust for the desired output volume.

BUILDING THE SOUND...

- The first tonal shaping circuitry are the *Character Filters* next to the GAIN control. These filters provide for a preshape EQ prior of further fine tuning of your sound.
- Enable the filters by pressing the *Filter Active* pushbutton and explore the filter section.
- The clean channel also features the use of a tube buffer for adding those extra harmonics by pressing the *Tube Mode* switch.
- If you need to refine your dynamics, adjust the COMP/LIMIT knob to your needs.
- Engage the drive channel by pressing the *Drive Active* button. Now you have full control of the drive circuitry with its' EQ. Turn up the LEVEL to the desired level compared with the level from the clean channel.
- Now, press the *Serial* button. This mode enables you to serial the two channels, so now you can dial in your drive sound with the aid of the filters and options of the clean channel.

This was a brief introduction of **EBS Fafner**. As you go on further in this manual, you will learn how to use and utilize all of the useful features that the **EBS Fafner** offers you.

GOOD LUCK !

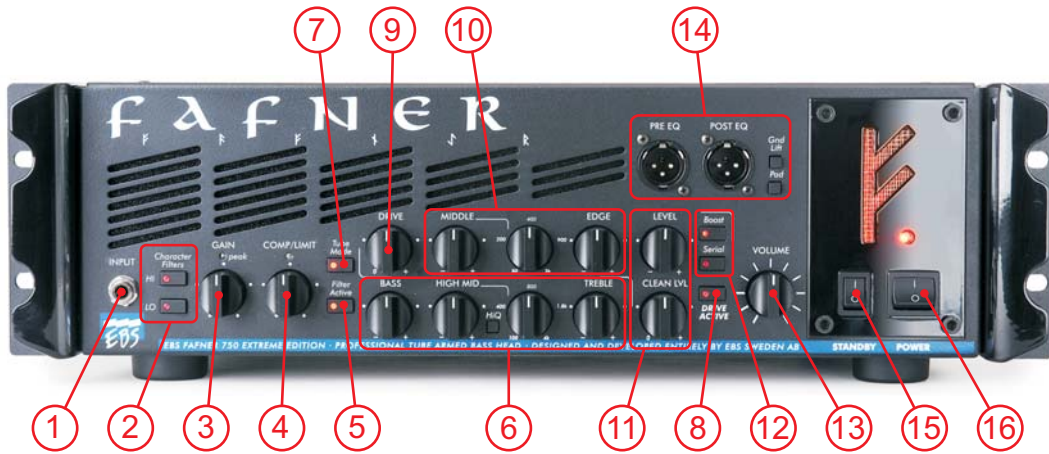

FUNCTIONAL DESCRIPTION FRONT PANEL CONTROLS:

① INPUT - A low noise, high impedance instrument input that will interface with passive and active instruments perfectly.

② CHARACTER FILTERS - The EBS Fafner provides two *preshape* filter, *Hi* and *Lo*, which operate independently from the other preamp functions. This gives the user the opportunity to preshape the sound before the final processing with the other features of the preamp..
When pressed to their's inner position, boost is achieved in bass and treble ranges respectively. These filters can be contolled remotely. Please refer to the rear panel description of the remote jacks.

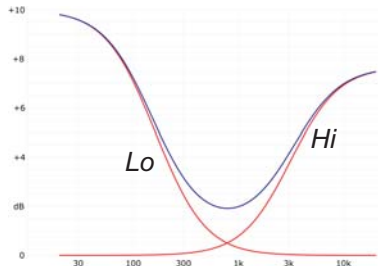

③ GAIN - Control to adjust the instruments' signal strength to the right operating level in the EBS Fafner.
For optimum basic signal level, turn up the GAIN knob until the PEAK led starts flashing from the strongest signal from the instrument.

Note: A correctly set GAIN is vital for the signal processing to work properly in the EBS Fafner.

④ COMP/LIMIT - A low noise compressor/limiter that works fast and effectively, tightening up the sound and preventing the bass head from saturating at peaks when approaching the headroom limit. A string may be plucked very hard and fast, without any greater difference in level or side effects.
The COMP/LIMIT knob sets the compression ratio, i.e. The signal strength relation between the input and output; the higher ratio the more compression.

DRIVE CHANNEL IN PARALLEL MODE:

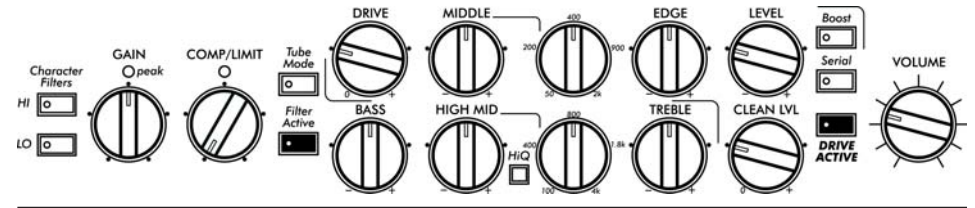

DRIVE CHANNEL IN SERIAL MODE:

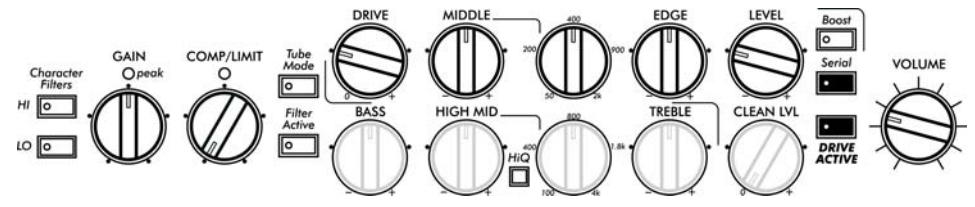

DRIVE CHANNEL IN SERIAL MODE, FILTERS ACTIVE:

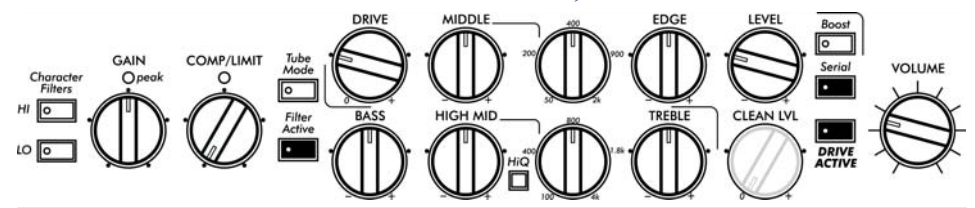

DRIVE CHANNEL IN SERIAL/PARALLEL MODE:

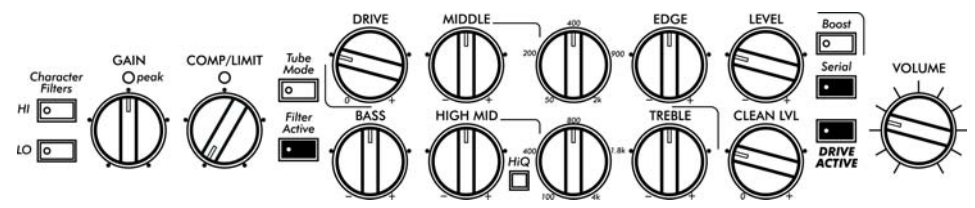

CLEAN CHANNEL IN BYPASS:

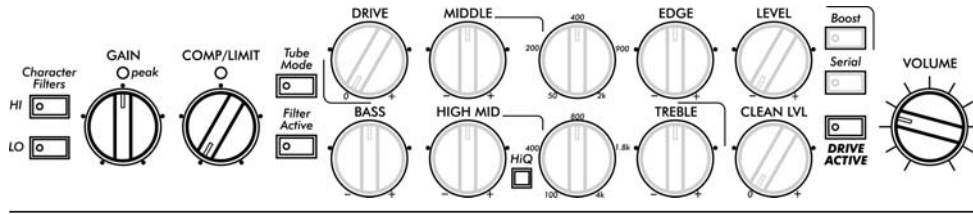

CLEAN CHANNEL FILTERS ACTIVE:

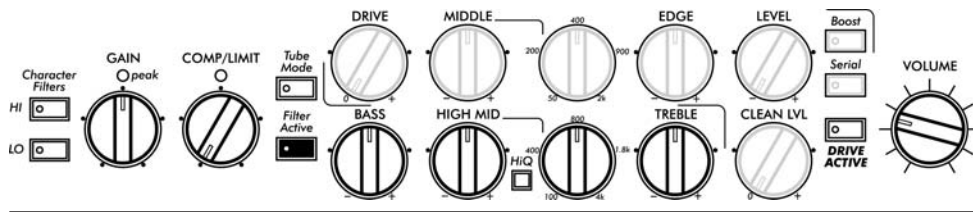

DRIVE CHANNEL ACTIVE:

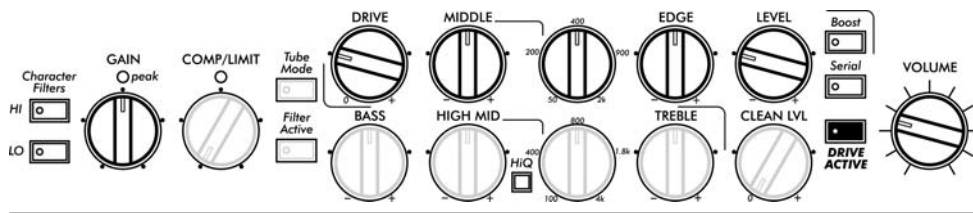

CLEAN CHANNEL IN DRIVE ACTIVE, BYPASS:

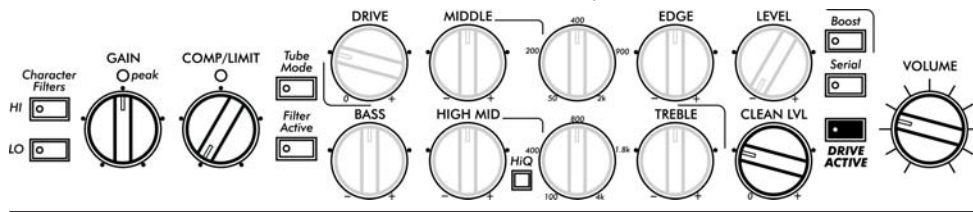

CLEAN CHANNEL IN DRIVE ACTIVE, FILTERS ACTIVE:

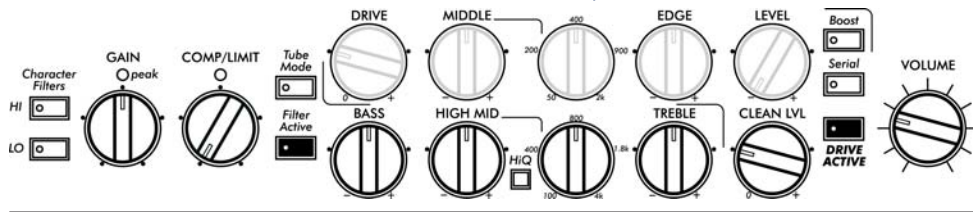

The LED intensity dynamically indicates the amount of compression during play.

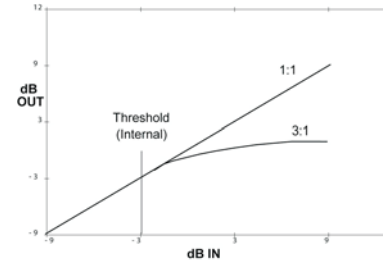

⑤

FILTER ACTIVE – This switch activates the filter section described under point 6. This function can be controlled remotely. Please refer to the rear panel description of the remote jacks.

⑥

FILTERS - The filter section contains three enhanced performance filters:

BASS is a 'shelving' type 12dB/oct slope phase compensated bass filter with a wide gain range.

HIMIDDLE has an frequency range of 100-4k Hz. This filter facilitates total control over the mids, with a wide bandwidth giving a natural and non-peaking result. The **Hi-Q** switch selects higher gain and a narrow band for precise control of the mids.

TREBLE is a shelving type filter controlling the higher mids and treble registers, giving presence and ambience to the sound.

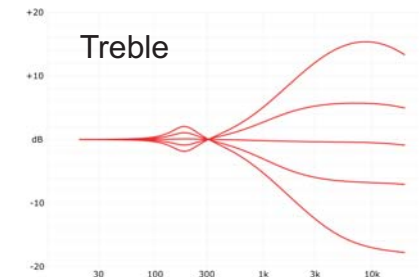
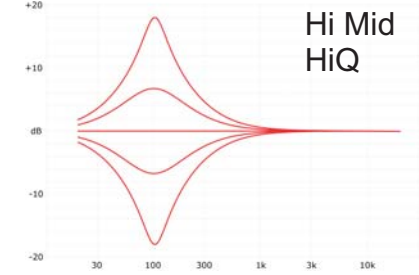
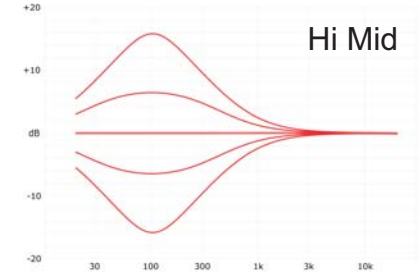

⑦

TUBE MODE - This switch activates a pure tube buffer providing a touch of the distinguished warmth and depth of tubes. While reaching the headroom limit, this buffer will provide a true tube soft clip limiting function, useful for adding those extra true tube harmonics.

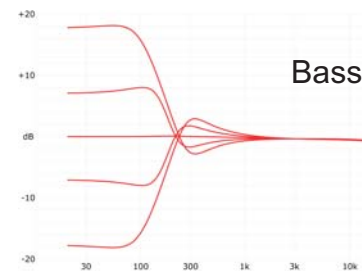

8

DRIVE ACTIVE – This switch activates the drive section with all of its features. This function can also be controlled remotely. Please refer to the rear panel description of the remote jacks.

9

DRIVE - This knob controls the amount of gain in the tube stage, and provides an extra gain all the way up to 34 dB. This control also compresses the sound when turning up the level of the knob up to maximum, producing pure tube limitation.

10

POST DRIVE EQ - This filter section contains two high performance filters for fine tuning your drive channel sound:

MIDDLE has a frequency range of 50-2k Hz and facilitates total control all from the bass timbres up to the mids, controlling with precision the definition of the mids.

EDGE is “bell” type filter controlling the higher mids for setting definition, presence and ambience to the sound.

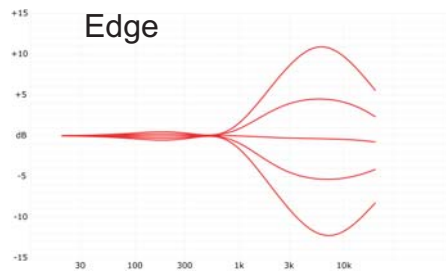
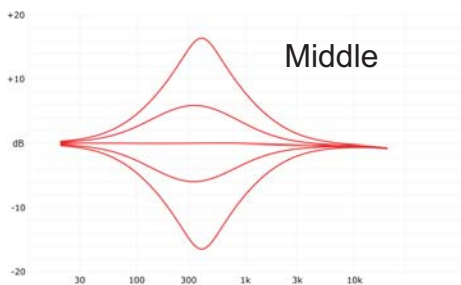

11

LEVEL - This knob controls the level of the drive channel. The drive channel must be activated for this control to work.

CLEAN LVL - This knob controls the level of the clean channel to be mixed in with the drive channel sound. The drive channel must be activated for this control to work.

12

DRIVE CHANNEL OPTIONS:

BOOST – The boost switch makes possible a choice of two different overdrive types. When this switch is in its' inner position a flat, or linear, gain is achieved with the drive knob. However, when this switch is in the outer position, the frequencies below 350 Hz is bypassed, producing a warmer distortion without saturation, allowing the player adding more low bass than with conventional bass amps. The bass is compensated over the tube stage, giving the same bass response up to mid distorted sounds.

SERIAL - The serial switch selects the source for the drive channel. In outer position the source is taken directly after the gain and preshape filters. In inner position, the source is taken after the clean channel, including all of the clean channel features; filters, compressor and tube buffer.

8

REMOTES – The EBS Fafner is equipped with two remote jacks for controlling with foot switches the **character filters**, **filter active**, **drive active** functions on the front panel plus a mute function.

You may use the RM-4 pedal from EBS, or any standard footswitch pedal making connection to ground for each of the remote functions. In addition, these jacks provide current suitable for LED indication.

Note: Each of the functions switches on the front panel needs to be set to inner position in order to be remotely controlled.

9

SPEAKER OUTPUTS – Connect your speakers here. Care should be taken when connecting speakers so that the minimum total impedance is not lower than 2 ohms.

Note: Lower impedance than 2 ohms may cause permanent damage to the amp.

EBS will not take responsibility for eventual hearing damages caused by the powerful EBS Fafner.

10

AC INPUT – Connect only to the indicated AC voltage. If the mains fuse blow, replace only with the same type.

11

SYSTEM FAN – The system fan is a temperature controlled fan and will increase the speed according to the temperature and power output.

IMPORTANT: Make sure not to cover the ventilation opening!

SOMETHING ABOUT TUBES...

Although the ECC83 (12AX7) is a long life tube, it is recommended replacing the tube once a year to guarantee perfect operation.

In order to replace the tube, please follow the instruction below:

- 1) Power off and unplug the amplifier from the mains.
- 2) Let the amplifier fully discharge for at least five (5) minutes.
- 3) Remove the top cover by removing the four bolts at the amps left at right side, and the two bolts on the top cover next to the rear panel.
- 4) Locate the tube at the poweramp board and carefully remove the tube.
- 5) Place the new tube in place. Be sure that no tube pins are damaged.
- 6) Place the top cover in place.

Done!

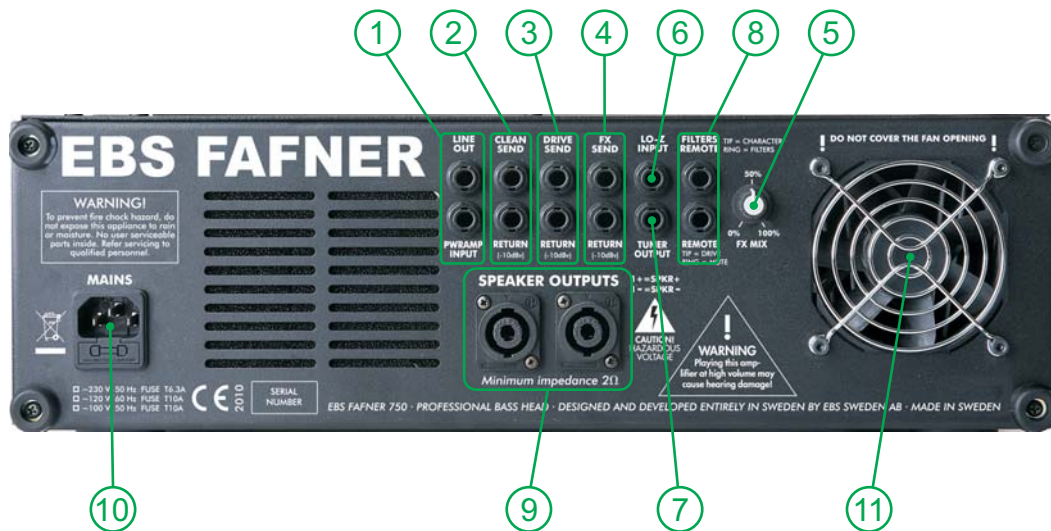

FUNCTIONAL DESCRIPTION REAR PANEL:

1 POST LOOP - This serial loop is situated after the VOLUME control. Use the *LINE OUT* for connecting to another poweramp or to another Fafners *POWERAMP INPUT* for connecting two amps together.

2 CLEAN CHANNEL LOOP - This is the clean channel serial loop and is only active for the clean channel.

3 DRIVE CHANNEL LOOP - This is the drive channel serial loop and is only active for the drive channel.

4 EFFECTS LOOP - This is the common effects loop available for both channels and is situated after the individual channel loops.

5 FX MIX - This control controls the mix level for the common *EFFECTS LOOP*, from 0% (off) to 50% (parallel), to 100% (serial).

6 LO-Z INPUT - This input is a low impedance input suitable for connecting wireless systems or other sources without the need of using the input on the front panel. When connecting to the input on the front panel, this input is disabled.

7 TUNER OUT - This low impedance output is suitable for driving tuners. The signal from this output is identical to the instruments' signal.

13 VOLUME - The VOLUME knob controls all volume in the unit, controlling the poweramp and LINE output. The balanced outputs (XLR) are not affected by the setting of this knob.

14 BALANCED OUTPUTS - A balanced output functions as a high quality line box for connecting to PA mixing consoles or to studio or broadcast recording units, with high noise immunity. The EBS Fafner is equipped with two balanced outputs, in order to be able to monitor both the input signal and the signal from the entire preamp.

The *PRE EQ* output is a direct copy of the signal present at the input jack, so no controls effect this output.

The *POST EQ* outputs the signal after the entire preamp and is not dependent of the output volume.

Lifting ground is a great aid in many occasions. When required, set the *Gnd Lift* switch at the front panel to inner position to disconnect the ground from the outputs.

The *Pad* switch sets the option of either studio standard level, in outer position, or when pressed microphone level.

15 STANDBY - This switch disconnects the poweramp from the speaker outputs, mutes the line output and the balanced outputs. The mute function can also be remotely controlled. Please refer to the rear panel description of the remote jacks.

16 POWER - Switches the amp on or off.

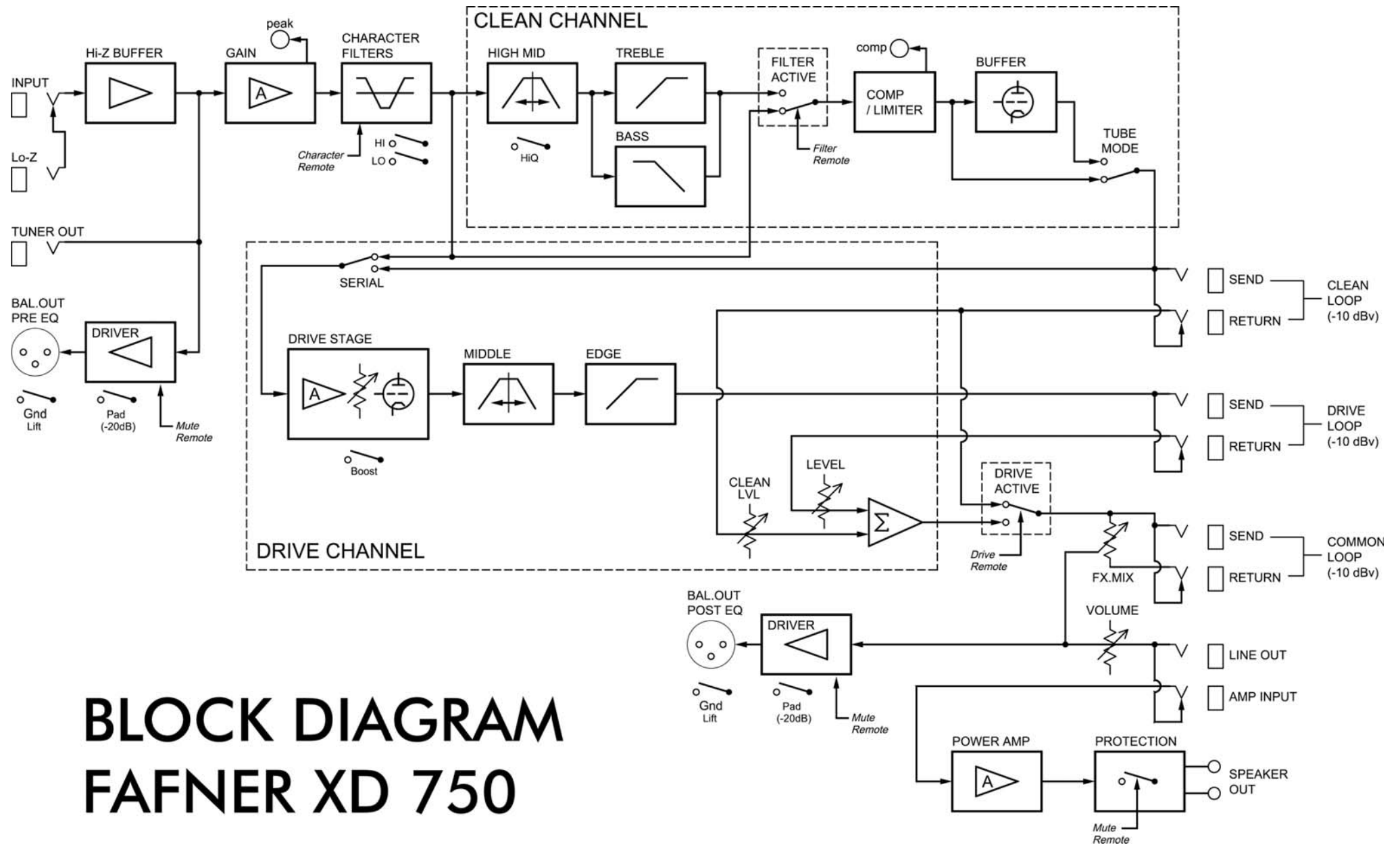

BLOCK DIAGRAM FAFNER XD 750