

MAGNI 500

PROFESSIONAL BASS COMBO



About the EBS Magni 500 Bass Combo!

The name 'Magni' stems from a character in Norse mythology – Magni, son of Thor (the God of Thunder). The word Magni translates to 'Strong' and is indeed significant for these thunderous Magni 500 bass combos!

The Magni 500 combo is based on the Reidmar 470 amp design. It is available in two configurations, sporting either 2x10" or 1x15" speakers, and a tweeter. The rig can be extended with an 8 ohm passive speaker cabinet.

The Magni 500 is designed and developed in the heart of Sweden by EBS.

GETTING STARTED...

1. Carefully unpack the bass combo.
2. Check that all knobs are set fully counter clockwise besides the EQ controls marked BASS, MIDDLE and TREBLE which should be set to mid position. Make also sure all push switches are set to their outer positions. Now the EBS Magni 500 settings are "zeroed" and ready to be personalized.
3. If you add another cabinet, make sure the impedance of that cabinet is not below 8 ohms.
4. Turn on the POWER switch.
5. Plug in your bass. While plucking the strings as hard as you would during your hardest playing, gradually increase the GAIN knob until the peak LED starts to flash at peaks.
6. Move over to the VOLUME knob and adjust for the desired output volume.

BUILDING THE SOUND...

7. The first tonal shaping circuitry is the Character Filter next to the GAIN control. This filter provides a preshape EQ prior to further fine tuning of your sound.

8. Enable the filters by pressing the Filter Active pushbutton and explore the filter section. Play your bass. Note that there isn't any difference in sound yet.

9. The filters are basically of the boost/cut design. This means that the level controls marked with + and - signs, either boost or cuts the selected frequency band. Further, the MIDDLE section has got a frequency control for precise adjustment of the midrange.

10. Gradually increase or decrease the level and vary the frequency of the middle filter when operating the middle filter. Notice how the sound is effected. An A/B comparison can be made by toggling the filter active switch.

11. Proceed to the COMP/LIMIT knob. This control adjusts the compression and is useful when playing very dynamic or loud.

12. Turn up the COMP/LIMIT knob to mid and max position. Notice how the peaks in volume will straighten out as you play harder and harder.

13. Now, go on to the BRIGHT and turn it half way up. Play your bass. The BRIGHT filter is a high pass filter which works on the highest frequencies of the bass to give enhanced ambiance and presence.

This was a brief introduction and as you go on further in this manual, you will learn how to use and utilize all of the useful features that the EBS Magni 500 offers you.

EBS MAGNI 500 – BLOCK DIAGRAM

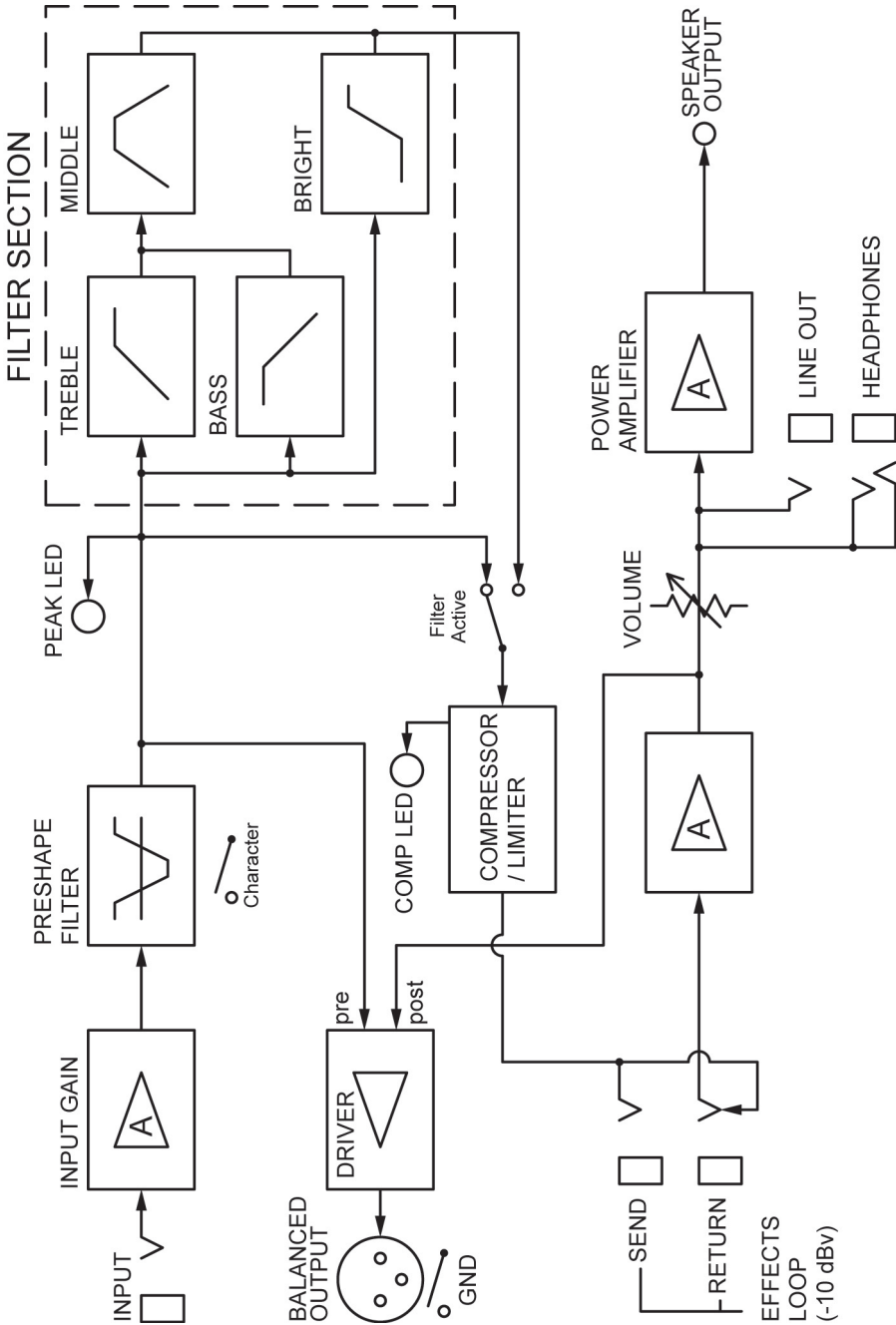

EBS MAGNI 500 – FRONT PANEL CONTROLS



1. INPUT -A low noise, high impedance instrument input that will interface with passive and active instruments perfectly.

2. CHARACTER FILTER -The EBS Magni 500 provides a preshape filter, Character, which operate independently from the other preamp functions. This gives the user the opportunity to preshape the sound before the final processing with the other features of the preamp. When on, boost is achieved in bass and treble ranges respectively, while the midrange has a slight drop in gain.

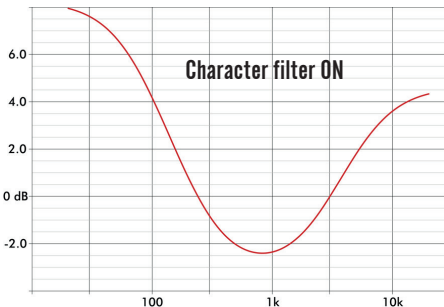

3. GAIN -Control to adjust the instruments’ signal strength to the right operating level in the EBS Magni 500. For optimum basic signal level, turn up the GAIN knob until the PEAK led starts flashing from the strongest signal from the instrument.

Note: A correctly set GAIN is vital for the signal processing to work properly in the EBS Magni 500.

4. COMP/LIMIT -A low noise compressor limiter that works fast and effectively, tightening up the sound and preventing the bass head from saturating at peaks when approaching the headroom limit. A string may be plucked very hard and fast, without any greater difference in level or side effects. The COMP/LIMIT knob sets the compression ratio, i.e. The signal strength relation between the input and output; the higher ratio the more compression. The LED intensity dynamically indicates the amount of compression during play.

5. FILTER ACTIVE – This switch activates the filter section described under point 6.

6. FILTERS -The filter section contains four enhanced performance filters:

BASS is a 'shelving' type 12dB/oct slope phase compensated bass filter with a wide gain range.

MIDDLE has an extended frequency range of 100-6000 Hz. This filter facilitates total control over the mids, with a wide bandwidth giving a natural and non-peaking result using frequency dependent gain. In addition, at minimum setting this filter facilitates a notch function, suitable for cutting an exact frequency or eliminating acoustic coupling.

TREBLE is a shelving type filter controlling the higher mids and treble registers, giving presence and ambience to the sound.

BRIGHT is an advanced high pass filter capable of producing bright high treble timbre, without adding practically any noise.

7. VOLUME -The **VOLUME** knob controls all volume in the unit, controlling the poweramp and **LINE** output. The balanced output (XLR) is not affected by the setting of this knob.

8. PILOT LAMP -Indicates power on condition.

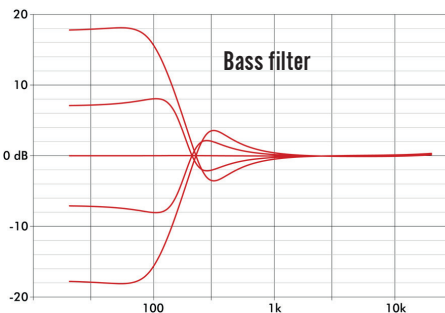

Midrange filters

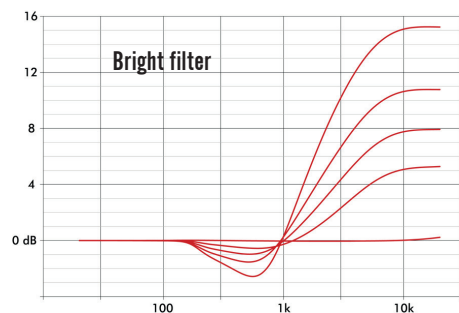
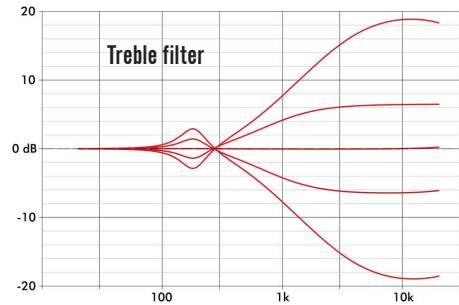
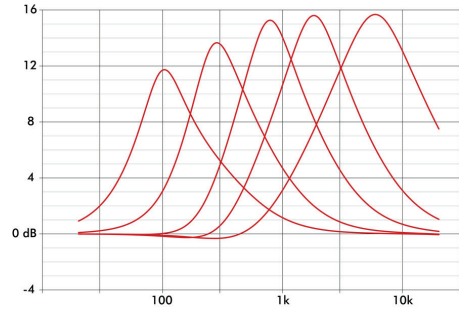
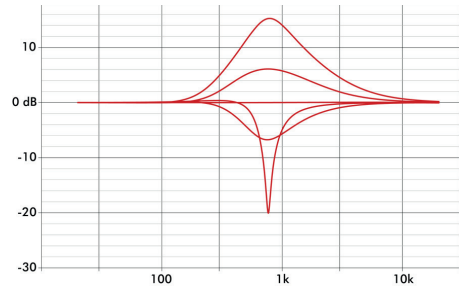

EBS MAGNI 500 — REAR PANEL FEATURES



1. BALANCED OUTPUT -A balanced output functions as a high quality line box for connecting to PA mixing consoles or to studio or broadcast recording units, with high noise immunity. The volume level does not effect this output.

2. GND LIFT SWITCH -Lifting ground is a great aid in many occasions eliminating ground noise and hum. When required, set this switch to Lift position to disconnect the ground from the balanced output.

3. PRE/POST EQ SWITCH -The switch selects the signal source. In the inner position this switch selects the overall sound included settings on the EQ, otherwise, in the lower position an uncolored sound is taken immediately after the amplifiers input.

4. EFFECTS LOOP – This is a serial effects loop for the use of external units such as box or rack effects. Nominal level is set for use with standard stomp boxes. The loop puts the external effects after the filter, compressor and drive sections.

5. LINE OUT -This is a fullrange output that will drive multiple poweramps, extending the power of the system. The signal present at this output is taken after the volume control.

6. PHONES - 1/4" stereo contact to connect a pair of standard headphones.

7. SPEAKER OUTPUT – Option to connect an extra speaker here. The impedance must not be lower than 8 ohms.

Warning: Lower impedance than 8 ohms may cause permanent damage to the amp.

8. MAINS SELECTOR SWITCH -Selects the operating mains voltage. Unplug the amp before selecting the mains voltage!

9. MAINS – Connect only to the indicated mains AC voltage and replace fuse if needed only with same type and value.

10. POWER -Switches the amp on or off.

EBS MAGNI 500 – AVAILABLE MODELS**EBS MAGNI 500 - MA10**

2x10" Speaker Configuration
Freq. range: 50-20.000 Hz
Weight: 21 kg / 46.7 lbs

**EBS MAGNI 500 - MA15**

1x15" Speaker Configuration
Freq. range: 30-20.000 Hz
Weight: 20,5 kg / 45 lbs



INPUT:	Input Impedance		1 Mohms // 100 pF	
GAIN:	Gain Range	min/max	-∞/ +30 dB	
	Gain Peak LED		+10 dBv	
	Frequency Response	+0 / -3 dB	20 -20.000 Hz	
CHARACTER:	Filter:	Type	Shelving High/Low Pass	
	Gain:	Low	+7 dB @ 40 Hz	
		Mid	-2dB@ 800Hz	
		High	+3 dB @ 10 kHz	
COMP/LIMIT:	Compressor Gain		0 dB	
	Attenuation	max	24 dB	
	Compression Ratio	max	3:1	
	Attack (80%)	typ.	<10 ms	
	Release (80%)	typ.	100 ms	
FILTER SECTION:	Bass Filter:	Type	12 dB/oct. Shelving	
		Gain Range	+/-18dB @ 60Hz	
	Middle Filter:	Type	Bandpass Filter	
		Frequency Range	100 -6.000 Hz	
		Q -Boost	0.7 -1.1	
		Q -Cut	0.8 ->10	
	Treble Filter:	Gain Range	+/-12-15 dB	
		Type	Shelving	
		Gain Range	+/-18dB@6kHz	
	Bright:	Type	Shelving	
Gain Range		+15/-0 dB @ 10 kHz		
BALANCED OUTPUT:	Output Level	Nominal	-10dBv	
	Frequency Response	+0/-3 dB	10-20.000 Hz	
	XLR Connections		1-GND, 2-Hot, 3-Cold	
	Options		GND Lift, Pre/Post EQ	
EFFECT LOOP:	Loop Signal Level	nominal	-10 dBv	
	Gain		Unity (1:1)	
	Output Impedance		100 ohms	
	Input Impedance		>50 kohms // 100 pF	
LINE OUT:	Output Impedance		100 ohms	
	Signal Level	nominal	0 dBv	
PHONES OUT:	Impedance	recommended	32 -200 ohms	
POWER AMP:	Continuous Output Power	@4 ohms	250 W RMS	
	Dynamic Output Power		470 W peak	
	Minimum Load		8 ohms (External Cabinet)	
	Impedance			
AUXILIARY INFO:	Protection		Short circuit, High temperature	
	Power Requirements		max 500 W	
	Mains Protection:		T2A Fuse (230V) T4A Fuse (100/120V)	
CABINET:	Speaker type		Ferrite	
	Impedance (total)		8 ohms	
	Crossover Freq.		4.5 kHz	
	Frequency range	MA10 (2x10")		50-20.000 Hz
		MA15 (1x15")		30-20.000 Hz
		typ.		94 dB 1W/1m
	Volume		50 liters	
	Power rating	MA10 (2x10")		300 W (RMS)
	Power rating	MA15 (1x15")		250 W (RMS)
	Measurements	(H x W x D)		560 x 440 x 365 mm / 22 x 17.3 x 14.4"
Weight	MA10		21 kg / 46.7 lbs	
	MA15		20,5 kg / 45 lbs	

Specifications are subject to change without notice!

EBS MAGNI 500 - PROFESSIONAL BASS COMBO

DESIGNED AND DEVELOPED BY EBS SWEDEN AB • GRINDSTUVÄGEN 44-46, SE-16733 BROMMA, SWEDEN
 PHONE +46 87350010, FAX: +4687350005 • E-MAIL: info@ebssweden.com WEB: www.ebssweden.com